



S K F B U S H I N G S

SKF

Contents

BUSHING SELECTION

World's Widest Bushing Stock Assortment	2
SKF Bushings – Product Guide	4
SKF Bushings – Technical Data	6
Bushing Selection – Overview of Technical Data	
Temperature range	7
Coefficient of friction	7
Load capacity	8
Sliding velocity	8
Shaft recommendations	9

PRODUCT SPECIFIC INFORMATION – TECHNICAL DATA

SKF Solid Bronze – The all-round runner	11
SKF Sintered Bronze – The fast runner	13
SKF Wrapped Bronze – The cross country runner.....	15
SKF PTFE Composite – The long runner	17
SKF POM Composite – The up-hill runner	19
SKF Stainless Backed Composite – The smooth & shiny runner	21
SKF PTFE Polyamide – The jogging runner	23
SKF Filament Wound – The heavy duty runner	25

ASSORTMENT

SKF Solid Bronze – The all-round runner	28
SKF Sintered Bronze – The fast runner	30
SKF Wrapped Bronze – The cross country runner	32
SKF PTFE Composite – The long runner	34
SKF POM Composite – The up-hill runner	38
SKF Stainless Backed Composite – The smooth & shiny runner.....	41
SKF PTFE Polyamide – The jogging runner	42
SKF Filament Wound – The heavy duty runner	44

World's Widest Bushings



SKF – number one in bearings

Made by SKF® stands for excellence. It symbolises our consistent endeavour to achieve total quality in everything we do. We provide our customers with outstanding bushing quality.

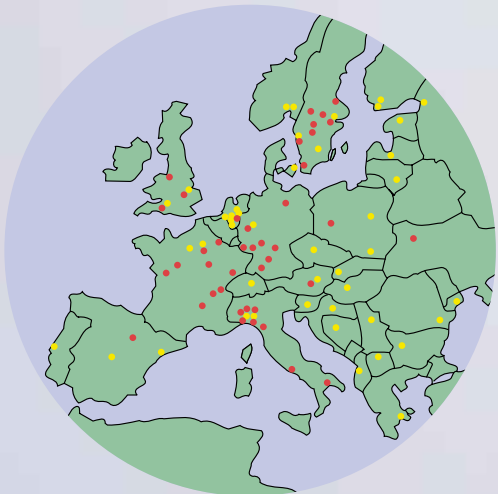

SKF – your only bushing partner

Using our global sales network and logistics expertise we offer a delivery service level far beyond that of any competitor. With the world's widest bushing stock assortment distributors and end users now have the solution for most industries and application needs from one single source.



SKF – we help to select the right bushing for you

Throughout the world we are recognised as the leading rolling bearing manufacturer. We are renowned for our excellent technical support and application know-how. However, we are also a major player in the plain bearing field: spherical plain bearings, rod ends and now a much expanded range of bushings. The **new** product selection guide in this catalogue simplifies the selection of bushings from our expanded range for you.

ing Stock Assortment

SKF Solid Bronze

The all-round runner

The traditional and robust bushing material

SKF Sintered Bronze

The fast runner

Oil impregnation allows very high sliding velocity

SKF Wrapped Bronze

The cross country runner

Excellent in dirty environments due to lubrication pockets

SKF PTFE Composite

The long runner

Long maintenance-free operating life due to low friction

SKF POM Composite

The up-hill runner

Optimal combination of low maintenance under tough running conditions

SKF Stainless Backed Composite

The smooth & shiny runner

The non-corrosive maintenance-free long runner

SKF PTFE Polyamide

The jogging runner

The cost efficient maintenance-free bushing





SKF Filament Wound

The heavy duty runner

The maintenance-free bushing for extreme running conditions

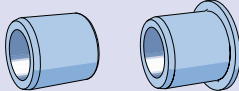
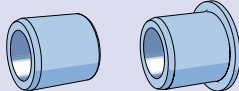
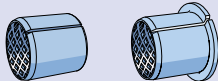

SKF Bushings –

			
	Solid Bronze The all-round runner	Sintered Bronze The fast runner	Wrapped Bronze The cross country runner
Self-lubricating performance	–	+	–
Maintenance-free operation	–	+	0
Dirty environment	+	0	++
Corrosion resistant	+	0	+
High temperature	+	–	+
High load	0	–	0
Shock loads/vibrations	+	0	+
High sliding velocity	–	++	0
Low friction	–	+	–
Poor shaft surface finish	+	–	0
Small operating clearance	–	0	0
Insensitive to misalignment	+	0	0
Low price level	0	+	+
Assortment			
Product series designation	PBM PBMF	PSM PSMF	PRM PRMF
Page	28	30	32





Product Guide

				
PTFE Composite The long runner	POM Composite The up-hill runner	Stainless Backed Composite The smooth & shiny runner	PTFE Polyamide The jogging runner	Filament Wound The heavy duty runner
++	+	++	++	++
++	+	++	++	++
-	0	-	-	+
0	0	++	++	++
++	0	+	0	+
+	++	+	0	++
0	0	0	-	++
+	+	+	0	-
++	++	++	0	++
-	0	-	0	0
++	+	+	0	-
-	0	-	0	+
++	++	-	++	-
				
PCMF..B PCMW..B PCM..B PCMS..B	PCM..M PCMW..M PCMS..M	PI	PPM PPMF	PWM
34	38	41	42	44

Suitable (0)

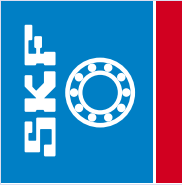
Not suitable (-)

SKF Bushings – Technical Data

									
		Solid Bronze The all-round runner	Sintered Bronze The fast runner	Wrapped Bronze The cross country runner	PTFE Composite The long runner	POM Composite The up-hill runner	Stainless Backed Composite The smooth & shiny runner	PTFE Polyamide The jogging runner	Filament Wound The heavy duty runner
Temperature range, °C		-40 .. +150	-10 .. +100	-40 .. +150	-200 .. +250	-40 .. +110	-150 .. +150	-30 .. +110	-50 .. +140
Friction coefficient, μ		0,08 .. 0,15	0,05 .. 0,10	0,08 .. 0,15	0,03 .. 0,08	0,04 .. 0,12	0,03 .. 0,08	0,06 .. 0,15	0,03 .. 0,08
Permissible load, N/mm ² – dynamic – static		50 140	10 50	40 120	80 250	120 250	80 300	40 80	140 200
Permissible sliding velocity, m/s		0,5	0,25 .. 1,0	1,0	2,0	2,0	1,5	1,0	0,5
Shaft tolerance		e7 – e8	f7 – f8	e7 – f8	f6 – h7	h7 – h8	g6 – f7	h8 – h9	h7 – h8
Housing tolerance		H7	H7	H7	H7	H7	H7	H7	H7
Shaft roughness, R _{ar} , μm		0,8 .. 1,6	0,2 .. 0,8	0,4 .. 0,8	0 .. 0,4	0 .. 0,8	0 .. 0,4	0 .. 0,8	0 .. 0,8
Shaft hardness, HB		180 – 400	200 – 300	150 – 400	300 – 600	150 – 600	300 – 600	100 – 300	200 – 600
Assortment									
Product series designation		PBM PBMF	PSM PSMF	PRM PRMF	PCMF .. B PCMW .. B PCMS .. B	PCM .. M PCMW .. M PCMS .. M	PI	PPM PPMF	PWM

The sliding velocity can be calculated using

$$v = n \times \pi \times d / (60 \times 1\,000)$$

where

v = sliding velocity, m/s
n = rotational speed, r/min
d = bore diameter of bushing, mm

The specific bearing load can be calculated using

$$p = F / (d \times b)$$

where

p = specific bearing load, N/mm²
F = bearing load, N
d = bore diameter of bushing, mm
b = width of bushing, mm

Bushing Selection

Overview of Technical Data

Temperature range

Ambient temperature range (°C) for the different SKF sliding materials under normal operating conditions.

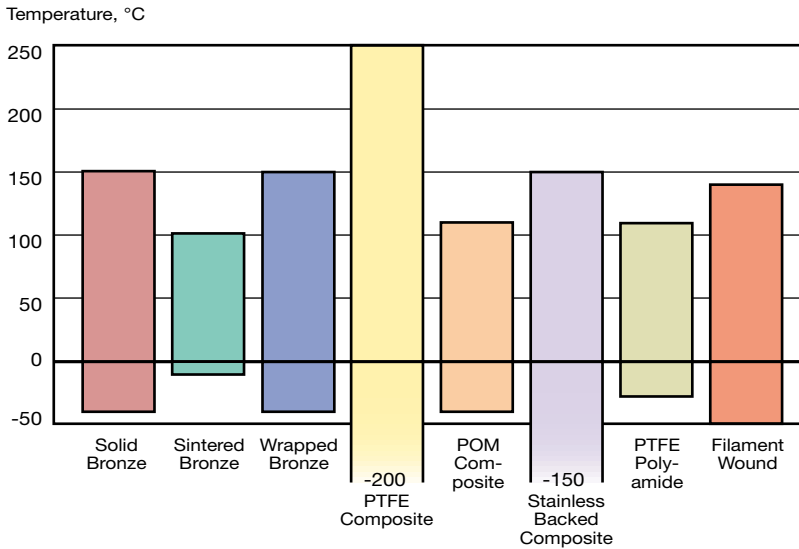

The temperature range for SKF Solid and Wrapped Bronze bushings can be extended by using special lubricant.

Coefficient of friction

Coefficient of friction (μ) under dry or initially lubricated operating conditions (typical values) for the different SKF sliding materials.

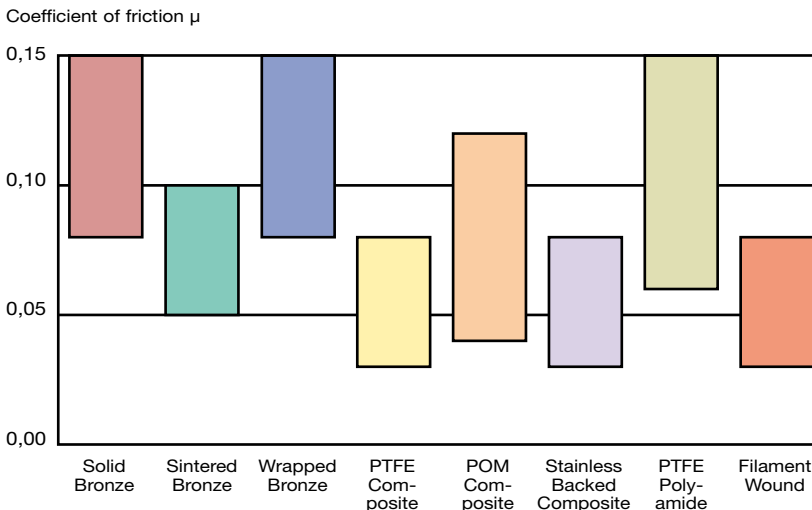

The friction of SKF sliding materials depends principally on the load, sliding velocity, surface roughness of the mating surface and the lubrication conditions. The lower coefficients of friction are obtained under high specific loads at low sliding velocities (not applicable to SKF Sintered Bronze).

Both higher and lower friction can occur under extreme conditions.

The load capacity for a specific application also depends on several other factors, such as type of load, sliding velocity and frequency of oscillation.

Load capacity

Permissible specific bearing load, p (dynamic), N/mm^2 , at a sliding velocity less than 0,01 m/s and permissible static load (N/mm^2) at $v = 0$ m/s for the different SKF sliding materials.

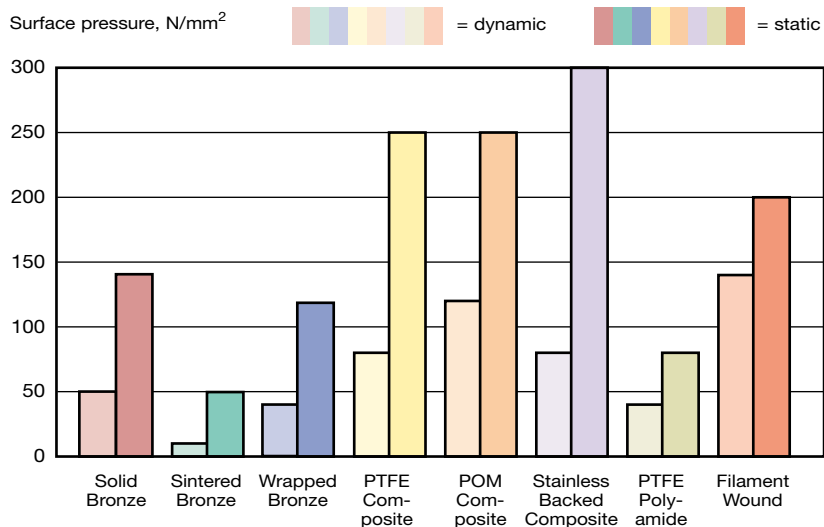

All sliding materials supplied by SKF can operate under rotational, oscillating and linear movements. The permissible sliding velocity for a specific application also depends on such factors as load, shaft surface and heat removed.

Sliding velocity

Permissible continuous sliding velocity (m/s) at a load less than 1 N/mm^2 under dry or initially lubricated operating conditions for the different SKF sliding materials.

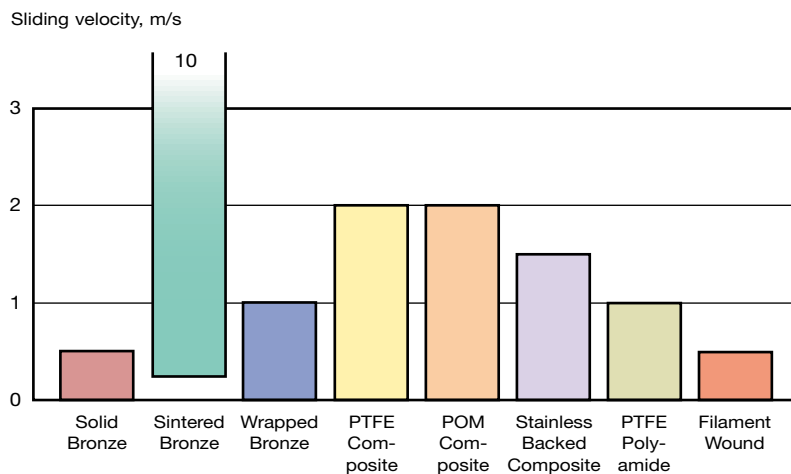

Shaft recommendations

Recommended ISO tolerance, surface roughness and surface hardness of the shaft for the different SKF sliding materials.

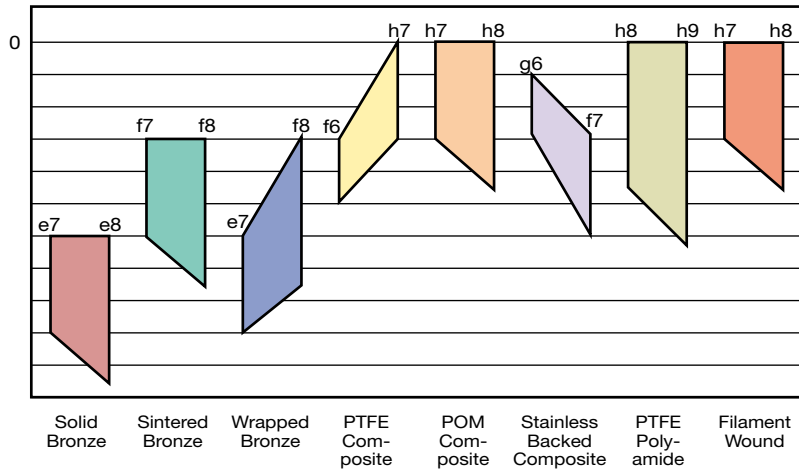

Shaft surface roughness R_a , μm

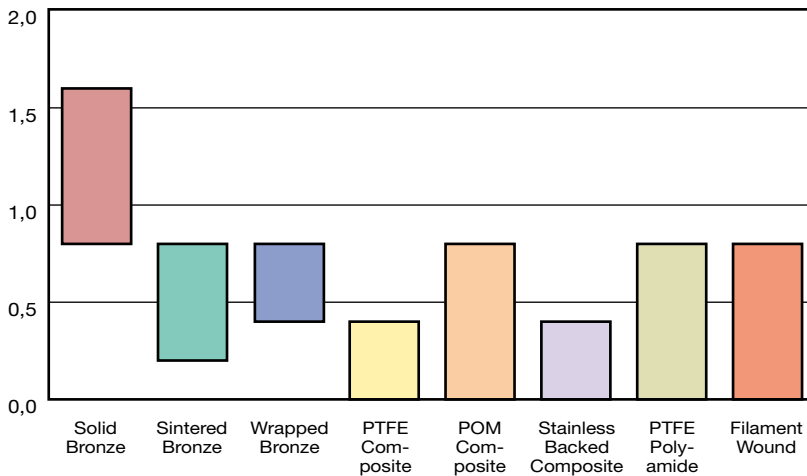

Shaft surface hardness, HB

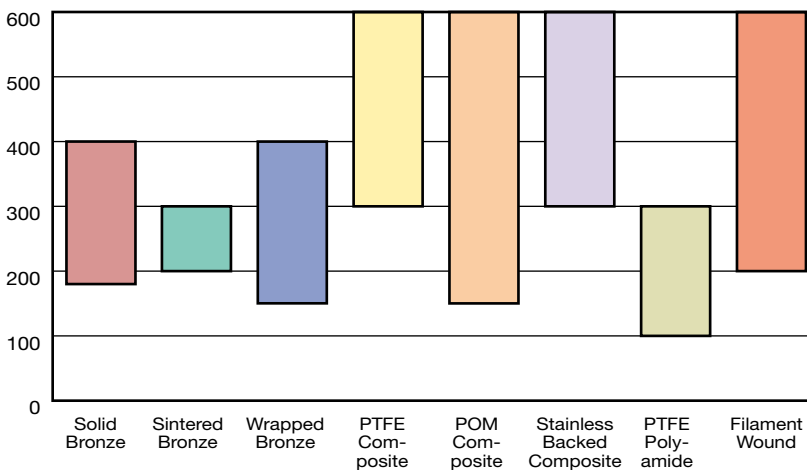

Higher tolerance grades can be used when the application demands are moderate.

The surface roughness often has a significant influence on the operating life. However, a surface roughness lower than $0,04 \mu\text{m}$ may have a negative effect.

The heavier the load, the harder the shaft should be.



SKF Solid Bronze

The all-round runner

THE TRADITIONAL AND ROBUST BUSHING MATERIAL

No other cylindrical bushing is used in as many and as varied applications as solid bronze bushings. The solid bronze material is ideally suited for highly demanding applications in tough environments. SKF offers a standard assortment of both plain and flanged cylindrical bushings in accordance with ISO 4379 and DIN1850.

SKF Solid Bronze bushings offer many features and advantages such as:

- insensitive to dirty environment
- resistant to shock loads and vibrations at slow speeds
- enable operation with a poor shaft surface finish
- good resistance to corrosive conditions

MATERIAL

SKF Solid Bronze bushings are made completely of tin bronze, CuSn10P, which has a very good machineability. All surfaces of the solid bronze bushings are machined.

MAIN APPLICATIONS¹⁾

SKF Solid Bronze bushings are intended for oscillating movements in both rotational and axial directions. SKF Solid Bronze bushings are not intended for rotating movements at high or medium speeds.

Examples of applications are:

- construction machinery
- transport equipment
- pulp and papermaking machinery
- off-shore equipment

LUBRICATION

SKF Solid Bronze bushings are intended to be lubricated with oil or grease. Lubrication not only improves the sliding properties, but also reduces wear and prevents corrosion. Grease is usually used when lubrication is periodical, while in exceptional cases, an oil bath is used. Seals are recommended when the bushing is to be used in an aggressive environment.

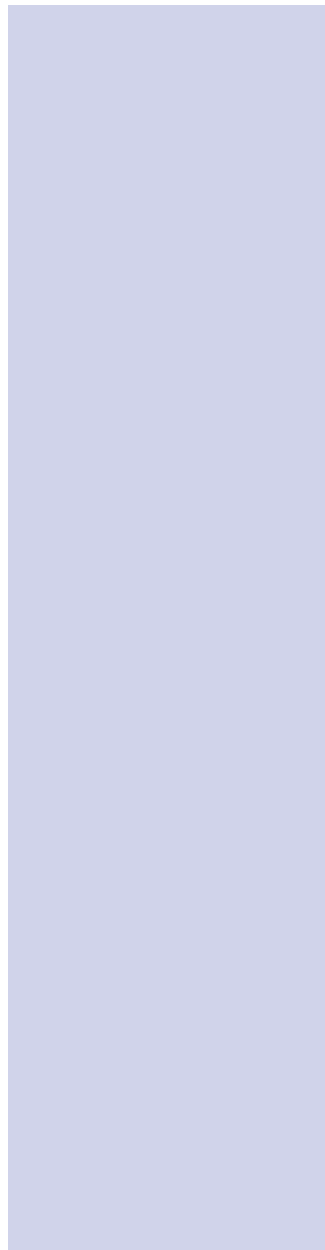

Characteristics:	
Permiss. load (dyn/stat), N/mm ²	50/140
Permiss. sliding velocity, m/s	0,5
Friction coefficient μ (greased)	0,08 .. 0,15
Temperature range, °C	-40 .. +150
Application recommendations:	
Shaft tolerance	e7 – e8
Housing tolerance	H7
Shaft roughness R_a , μm	0,8 .. 1,6
Shaft hardness, HB	180 .. 400

¹⁾ The performance of SKF Solid Bronze bushings depends on the interaction of load, lubrication, surface roughness, sliding velocity, and temperature encountered in specific applications.



SKF Sintered Bronze

The fast runner

OIL IMPREGNATION ALLOWS VERY HIGH SLIDING VELOCITY

SKF Sintered Bronze cylindrical bushings are all self-lubricating and maintenance-free. The sintered bronze bushings consist of a porous bronze matrix impregnated with lubricant. The permissible sliding velocity for sintered bronze bushings is very high, which makes the bushings suitable for rotating applications. SKF offers a full range of both plain and flanged cylindrical bushings in accordance with ISO 2795.

SKF Sintered Bronze bushings offer many features and advantages such as:

- very high sliding velocity
- no external lubrication required
- maintenance-free operation
- good frictional properties

MATERIAL

SKF Sintered Bronze consists of a sintered metallic bronze matrix with fully impregnated porosity. The material composition in SKF Sintered Bronze bushings is SINT A50 with a porosity volume of 28 % impregnated with mineral oil. Machining or grinding of the bearing surface of a porous sintered bushing is not recommended due to the risk of closing the bearing pores.

MAIN APPLICATIONS¹⁾

SKF Sintered Bronze bushings are most suitable for applications with rotating movements and where the self-lubricating performance requirements are high.

Examples of applications are:

- electrical equipment
- household equipment
- printing machinery
- machine tools

LUBRICATION

While storing and mounting make sure that the bushing never comes into contact with any absorbent material, as this may drain the oil very quickly. It is therefore recommended to keep the bushing in the original packaging for as long as possible.

Additional lubrication is usually not necessary.

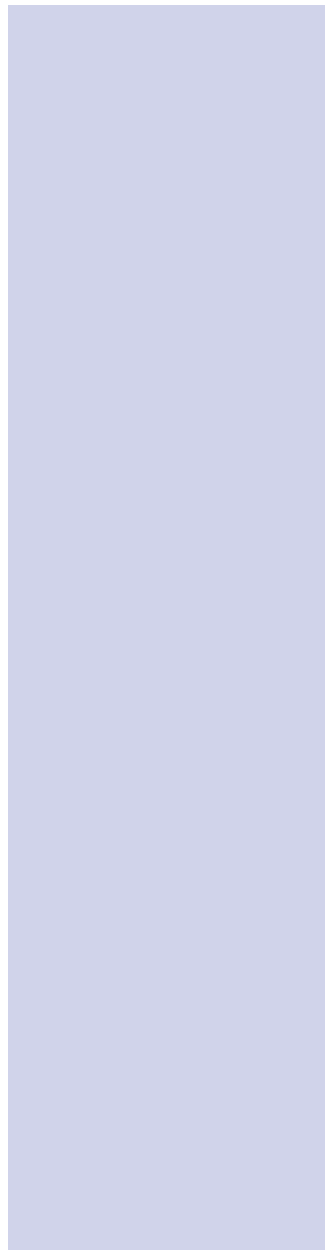

Characteristics:	
Permiss. load (dyn/stat), N/mm ²	10/50
Permiss. sliding velocity, m/s	10
Friction coefficient μ	0,05 .. 0,10
Temperature range, °C	-10 .. +100
Application recommendations:	
Shaft tolerance	f7 – f8
Housing tolerance	H7
Shaft roughness R_a , μm	0,2 .. 0,8
Shaft hardness, HB	200 – 300

¹⁾ The performance of SKF Sintered Bronze bushings depends on the interaction of load, lubrication, surface roughness, sliding velocity, and temperature encountered in specific applications.



SKF Wrapped Bronze

The cross country runner

EXCELLENT IN DIRTY ENVIRONMENTS DUE TO LUBRICATION POCKETS

SKF Wrapped Bronze cylindrical bushings are made completely of bronze. They are particularly suitable for applications which must be re-lubricated due to dirty environments. The sliding surface is provided with lubrication pockets which contribute to the enhanced lubrication performance. SKF offers a full range of both plain and flanged cylindrical bushings in accordance with ISO 3547 and DIN 1494.

SKF Wrapped Bronze bushings offer many features and advantages such as:

- insensitive to dirty environments
- resistant to shock loads and vibrations at slow speeds
- good resistance to corrosive conditions

MATERIAL

SKF Wrapped Bronze is made completely of bronze, CuSn8. The bushings are produced from strips which are then calibrated and wrapped. The working surface is machined and provided with diamond shaped indentations all over its sliding surface. These indentations serve as lubricant reservoirs, where lubricant is initially filled and progressively released during operation.

MAIN APPLICATIONS¹⁾

SKF Wrapped Bronze bushings are suitable for both radial and axial movements. The bushings are well suited for machinery in dirty environments where shock loads and/or vibrations occur.

Examples of applications are:

- agricultural machinery
- hoisting equipment
- construction machinery
- forest machinery

LUBRICATION

Lubrication improves the sliding properties, reduces wear and prevents corrosion since the metal surfaces of bushing and shaft are separated from each other. SKF Wrapped Bronze bushings are intended to be lubricated with grease or oil. All commonly used greases can be used. Seals are recommended when the bearing is to be used in an aggressive environment.

Diamond-shaped lubricant reservoirs



Characteristics:	
Permiss. load (dyn/stat), N/mm ²	40/120
Permiss. sliding velocity, m/s	1,0
Friction coefficient μ (greased)	0,08 .. 0,15
Temperature range, °C	-40 .. +150
Application recommendations:	
Shaft tolerance	e7 – f8
Housing tolerance	H7
Shaft roughness R _a , μm	0,4 .. 0,8
Shaft hardness, HB	150 – 400

¹⁾ The performance of SKF Wrapped Bronze bushings depends on the interaction of load, lubrication, surface roughness, sliding velocity, and temperature encountered in specific applications.



SKF PTFE Composite

The long runner

LONG MAINTENANCE-FREE OPERATING LIFE DUE TO LOW FRICTION

In applications where other materials have shown insufficient operating life SKF PTFE Composite dry sliding bearings can be the solution. SKF PTFE Composite is specially designed to operate without lubricant and is particularly suited for high load/high speed applications. SKF offers a full range of plain and flanged cylindrical bushings in accordance with ISO 3547 and DIN 1494 as well as thrust washers and strip.

SKF PTFE Composite bearings offer many features and advantages such as:

- maintenance-free operation
- very good frictional properties
- high load capacity
- very high operating temperatures
- high sliding velocity
- small operating clearance

MATERIAL

SKF PTFE Composite dry sliding bearings combine the mechanical strength of steel with the low friction of a PTFE-based self-lubricating sliding layer. The middle layer of porous tin bronze guarantees a strong bond between the backing and sliding surface and also improves the dissipation of heat generated during operation. To protect the bearings from corrosion the steel backing is tin-plated. All SKF PTFE Composite dry sliding bearings can be machined, except for the sliding surface.

MAIN APPLICATIONS¹⁾

SKF PTFE Composite dry sliding bearings are suitable for applications where the load and self-lubrication requirements are high.

Examples of applications are:

- automotive applications
- materials handling equipment
- home appliances and consumer goods
- textile machinery

LUBRICATION

The PTFE-based sliding surface permits smooth, low-friction operation without lubrication or maintenance. During a brief running-in phase part of the covering layer of SKF PTFE Composite dry sliding bearings is transferred to the mating surface and forms a physically bonded lubricant film.

To protect the mating surface from corrosion or for sealing reasons grease can be applied periodically. The presence or continuous supply of oil or other fluids may be advantageous and improve the performance of these bearings.

Cross section of SKF PTFE Composite

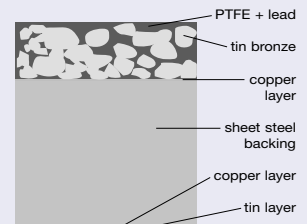

Characteristics:

Permiss. load (dyn/stat), N/mm ²	80/250
Permiss. sliding velocity, m/s	2,0
Friction coefficient μ	0,03 .. 0,08
Temperature range, °C	-200 .. +250

Application recommendations:

Shaft tolerance	f6 – h7
Housing tolerance	H7
Shaft roughness R_a , μm	0 .. 0,4
Shaft hardness, HB	300 – 600

¹⁾ The performance of SKF PTFE Composite bearings depends on the interaction of load, lubrication, surface roughness, sliding velocity, and temperature encountered in specific applications.
Note: Because of the lead content, SKF PTFE Composite should not be used in contact with food, beverage or pharmaceutical products. Try to use SKF POM or Stainless Backed Composite bushings instead.



SKF POM Composite

The up-hill runner

OPTIMAL COMBINATION OF LOW MAINTENANCE UNDER TOUGH RUNNING CONDITIONS

SKF POM Composite is referred to as pre-lubricated because it requires only a trace of lubricant to operate satisfactorily for long periods. The material is designed to operate with marginal lubrication and effectively fills the gap between fully lubricated bearings and dry sliding bearings. SKF offers a full range of plain cylindrical bushings in accordance with ISO 3547 and DIN 1494, as well as thrust washers and strip.

SKF POM Composite bushings offer many features and advantages such as:

- maintenance-free operation
- very good frictional properties
- high load capacity
- high sliding velocity
- small operating clearance

MATERIAL

SKF POM Composite sliding bearings are specially designed to operate with marginal lubrication. The sliding surface has a highly effective grease retention system with lubrication pockets, which serve as grease reservoirs. SKF POM Composite consists of three bonded layers: a copper plated steel backing strip and a sintered porous tin bronze matrix covered with an acetal (polyoxymethylene, POM) resin. To protect the bearing from corrosion the steel backing is tin plated. All SKF POM Composite sliding bearings can be machined. However, any machining of the sliding surface should only be undertaken in exceptional cases.

MAIN APPLICATIONS¹⁾

SKF POM Composite sliding bearings are suited for low-maintenance applications in tough running conditions. As a result of the lubricant retention pockets on the sliding surface, SKF POM Composite bearings are especially well suited for applications in dirty environments where lubricant cannot be supplied continuously or frequently.

Examples of applications are:

- agricultural equipment
- construction machinery
- materials handling equipment
- home appliances and consumer goods

LUBRICATION

SKF POM Composite bearings are designed to operate with marginal lubrication and should initially be lubricated with grease. It is not necessary to re-lubricate, but the presence or continuous supply of lubricant extends bearing life considerably. To protect the mating surface against corrosion, grease can be periodically applied.

Cross section of SKF POM Composite

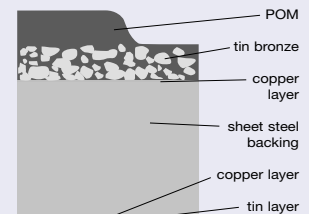

Characteristics:

Permiss. load (dyn/stat), N/mm ²	120/250
Permiss. sliding velocity, m/s	2,0
Friction coefficient μ	0,04 .. 0,12
Temperature range, °C	-40 .. +110

Application recommendations:

Shaft tolerance	h7 – h8
Housing tolerance	H7
Shaft roughness R_a , μm	0 .. 0,8
Shaft hardness, HB	150 – 600

¹⁾ The performance of SKF POM Composite bearings depends on the interaction of load, lubrication, surface roughness, sliding velocity, and temperature encountered in specific applications.



SKF Stainless Backed Composite

The smooth & shiny runner

THE NON-CORROSIVE MAINTENANCE-FREE LONG-RUNNER

SKF Stainless Backed Composite dry sliding cylindrical bushings* are specially developed for maintenance-free applications requiring high resistance to corrosive environments. SKF Stainless Backed Composite bushings are designed to operate without lubricant and are particularly suited for highly loaded applications. SKF offers a standard assortment of plain cylindrical bushings according to ISO 3547 and DIN 1494.

SKF Stainless Backed Composite bushings offer many features and advantages such as:

- excellent resistance to corrosive conditions
- very good frictional properties
- maintenance-free operation
- high load capacity
- high sliding velocity
- small operating clearance

MATERIAL

SKF Stainless Backed Composite is made out of a stainless steel backing strip (AISI 316TI) covered with PTFE fibres consisting of multi-filament yarns. The PTFE yarn is woven together with metal wire to produce a double-sided fabric, with only PTFE fibres on the sliding surface. The metal side of the fabric is continuously welded to the stainless steel backing. The PTFE side of the fabric is coated with a thermosetting resin preventing creep of the fabric under heavy loads. All SKF Stainless Backed Composite dry sliding bushings can be machined. However, any machining of the sliding surface should be avoided.

¹⁾ The performance of SKF Stainless Backed Composite bushings depends on the interaction of load, lubrication, surface roughness, sliding velocity, and temperature encountered in specific applications.

MAIN APPLICATIONS¹⁾

SKF Stainless Backed Composite bushings are able to sustain heavy load under low sliding velocity conditions in a corrosive environment.

Examples of applications are:

- food and packaging industry
- valves and pumps
- medical equipment
- printing and papermaking machines
- off-shore industry

LUBRICATION

SKF Stainless Backed Composite bushings are completely self-lubricating. The PTFE fibre and the thermosetting resin permit low friction operation with no lubrication or maintenance. During a brief running-in phase part of the PTFE covering layer is transferred to the mating surface.

* Branded Pydane in France. Pydane is a registered trademark of SKF.

Cross section of SKF Stainless Backed Composite

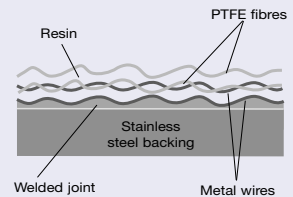

Characteristics:

Permiss. load (dyn/stat), N/mm ²	80/300
Permiss. sliding velocity, m/s	1,5
Friction coefficient μ	0,03 .. 0,08
Temperature range, °C	-150 .. +150

Application recommendations:

Shaft tolerance	g6 – f7
Housing tolerance	H7
Shaft roughness R _a , μm	0 .. 0,4
Shaft hardness, HB	300 – 600



SKF PTFE Polyamide

The jogging runner

THE COST EFFECTIVE MAINTENANCE-FREE BUSHING

The thermoplastic material of SKF PTFE Polyamide cylindrical bushings offers maintenance-free, dry sliding operation. SKF PTFE Polyamide bushings are designed for applications where other polymer bushings have shown insufficient operating life. The small wall thickness of these bushings ensures good heat conducting characteristics, enabling high sliding velocities. SKF offers a standard assortment of both plain and flanged cylindrical bushings according to ISO 3547 and DIN 1494.

SKF PTFE Polyamide bushings offer many features and advantages such as:

- maintenance-free operation
- cost efficiency
- excellent resistance to corrosive conditions
- electrically insulating properties

MATERIAL

SKF PTFE Polyamide comprises a thermoplastic base material, with both PTFE additives and glass-fibre. The material mix of SKF PTFE Polyamide bushings results in self-lubricating low wear performance and, in many applications, adequate load capacity.

MAIN APPLICATIONS¹⁾

SKF PTFE Polyamide bushings are suitable for applications where cost effective maintenance-free bushings are preferred.

Examples of applications are:

- textile industry
- medical equipment
- fitness equipment
- household equipment

LUBRICATION

SKF PTFE Polyamide is designed for dry operation. Lubrication can, however, improve the performance of these bushings. By continuously lubricating with grease, oil, water or other liquids, the operating speed can be increased still further. SKF PTFE Polyamide is resistant to most lubricant oils and greases.

¹⁾ The performance of SKF PTFE Polyamide bushings depends on the interaction of load, lubrication, surface roughness, sliding velocity, and temperature encountered in specific applications.

Characteristics:	
Permiss. load (dyn/stat), N/mm ²	40/80
Permiss. sliding velocity, m/s	1,0
Friction coefficient μ	0,06 .. 0,15
Temperature range °C	-30 .. +110
Application recommendations:	
Shaft tolerance	h8 – h9
Housing tolerance	H7
Shaft roughness R _a , μm	0 .. 0,8
Shaft hardness, HB	100 – 300



SKF Filament Wound

The heavy duty runner

THE MAINTENANCE-FREE BUSHING FOR EXTREME RUNNING CONDITIONS

SKF Filament Wound dry sliding cylindrical bushings are made out of resin and fibres wound in multi-layers. This material has been developed specially for applications with high loads, vibration and/or a corrosive environment. SKF Filament Wound bushings are most often interchangeable with solid bronze and steel bushings. SKF offers a standard assortment of plain cylindrical bushings in accordance with ISO 4379 and DIN 1850.

SKF Filament Wound bushings offer many features and advantages such as:

- high load capacity
- excellent resistance to shock loads and vibrations
- low sensitivity to edge pressure and misalignment
- maintenance-free operation
- excellent resistance to corrosive conditions
- very good frictional properties
- electrically insulating properties

MATERIAL

The modern technique of fibre winding, together with a specially developed resin matrix, combines the outstanding mechanical properties of glass-fibre with the excellent tribological behaviour of PTFE and high strength thermoplastic PES fibres. All SKF Filament Wound bushings can be mechanically machined, except for the sliding layer. In all cases care must be taken to avoid an excessive temperature rise as this could damage the bearing.

MAIN APPLICATIONS¹⁾

SKF Filament Wound bushings are suitable in applications where high loads and vibrations occur and where maintenance-free operation is preferred.

Examples of applications are:

- construction machinery
- agricultural and forestry machinery
- hoisting and conveyor equipment
- offshore equipment
- metal working machines

LUBRICATION

SKF Filament Wound bushings are dry running thanks to the unique sliding surface with PTFE and PES fibres in an epoxy resin. The sliding surface permits low friction operation with no lubrication or maintenance. However, the presence of lubricant offers protection against contamination and has no negative effect. Seals are recommended when the bushing is to be used in an aggressive environment.

Cross section of SKF Filament Wound

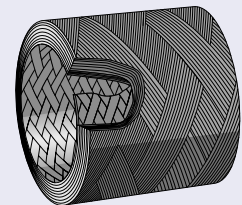

Characteristics:	
Permiss. load (dyn/stat), N/mm ²	140/200
Permiss. sliding velocity, m/s	0,5
Friction coefficient μ	0,03 .. 0,08
Temperature range, °C	-50 .. +140
Application recommendations:	
Shaft tolerance	h7 – h8
Housing tolerance	H7
Shaft roughness R _a , μm	0 .. 0,8
Shaft hardness, HB	200 – 600

¹⁾ The performance of SKF Filament Wound bushings depends on the interaction of load, lubrication, surface roughness, sliding velocity, and temperature encountered in specific applications.

Stock Assortment

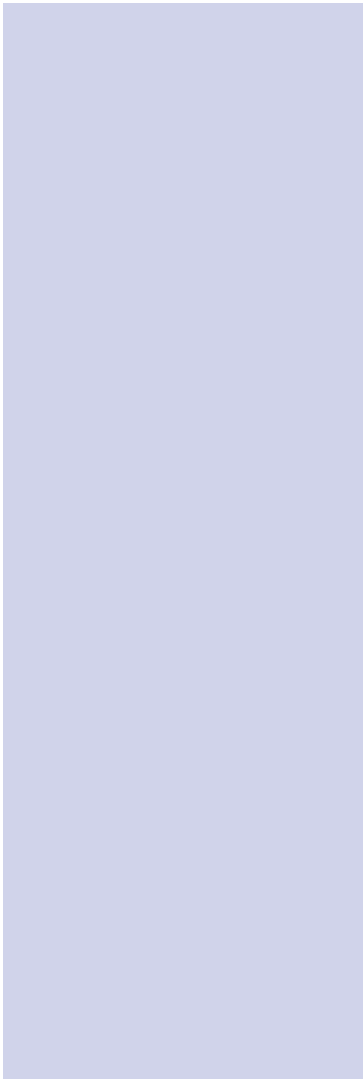

SKF Solid Bronze	28
SKF Sintered Bronze	30
SKF Wrapped Bronze	32
SKF PTFE Composite	34
SKF POM Composite	38
SKF Stainless Backed Composite	41
SKF PTFE Polyamide	42
SKF Filament Wound	44

SKF Solid Bronze – plain cylindrical bushings

Construction of designation:

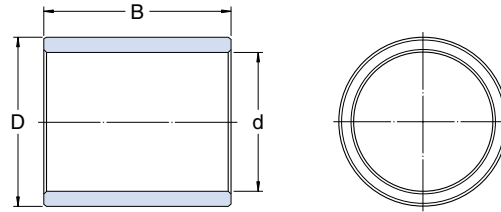
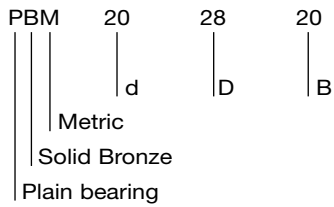

Designation	d mm	D mm	B mm
PBM 202820	20	28	20
PBM 202830	20	28	30
PBM 253525	25	35	25
PBM 253535	25	35	35
PBM 304030	30	40	30
PBM 304045	30	40	45
PBM 354535	35	45	35
PBM 354550	35	45	50
PBM 404840	40	48	40
PBM 405040	40	50	40
PBM 405060	40	50	60
PBM 455340	45	53	40
PBM 455545	45	55	45
PBM 455560	45	55	60
PBM 505850	50	58	50
PBM 506050	50	60	50
PBM 506070	50	60	70
PBM 556350	55	63	50
PBM 557050	55	70	50

Designation	d mm	D mm	B mm
PBM 607060	60	70	60
PBM 607560	60	75	60
PBM 607590	60	75	90
PBM 657560	65	75	60
PBM 658060	65	80	60
PBM 708070	70	80	70
PBM 708560	70	85	60
PBM 708590	70	85	90
PBM 758570	75	85	70
PBM 759070	75	90	70
PBM 809080	80	90	80
PBM 809570	80	95	70
PBM 8095100	80	95	100
PBM 9010580	90	105	80
PBM 9011080	90	110	80
PBM 90110120	90	110	120
PBM 100115100	100	115	100
PBM 10012080	100	120	80
PBM 100120120	100	120	120

Other dimensions available on request

SKF Solid Bronze – flanged cylindrical bushings

Construction of designation:

PBMF	20	26	15
	d	D	B
	Flanged		
	Metric		
	Solid Bronze		
	Plain bearing		

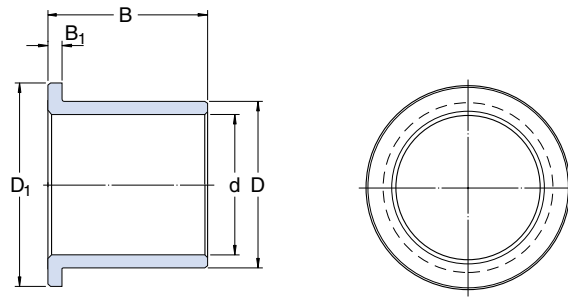

Designation	d mm	D mm	B mm	D ₁ mm	B ₁ mm
PBMF 202615	20	26	15	32	3
PBMF 202820	20	28	20	35	4
PBMF 253220	25	32	20	38	4
PBMF 253525	25	35	25	45	5
PBMF 303820	30	38	20	44	4
PBMF 304030	30	40	30	50	5
PBMF 354530	35	45	30	50	5
PBMF 354535	35	45	35	55	5
PBMF 405030	40	50	30	58	5
PBMF 405040	40	50	40	60	6

Designation	d mm	D mm	B mm	D ₁ mm	B ₁ mm
PBMF 455530	45	55	30	63	5
PBMF 455545	45	55	45	65	6
PBMF 506040	50	60	40	68	5
PBMF 506050	50	60	50	70	6
PBMF 607540	60	75	40	83	7,5
PBMF 607560	60	75	60	85	8
PBMF 708560	70	85	60	95	8
PBMF 809570	80	95	70	105	8

SKF Sintered Bronze – plain cylindrical bushings

Construction of designation:

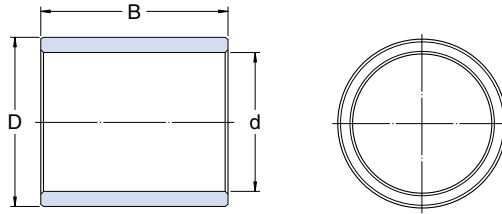
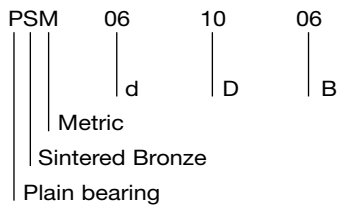

Designation	d mm	D mm	B mm
PSM 061006	6	10	6
PSM 061010	6	10	10
PSM 061206	6	12	6
PSM 061208	6	12	8
PSM 061212	6	12	12
PSM 081208	8	12	8
PSM 081212	8	12	12
PSM 081408	8	14	8
PSM 081412	8	14	12
PSM 081416	8	14	16
PSM 101410	10	14	10
PSM 101416	10	14	16
PSM 101610	10	16	10
PSM 101616	10	16	16
PSM 101620	10	16	20
PSM 121612	12	16	12
PSM 121620	12	16	20
PSM 121812	12	18	12
PSM 121816	12	18	16
PSM 121820	12	18	20
PSM 121825	12	18	25
PSM 141814	14	18	14
PSM 141820	14	18	20
PSM 142012	14	20	12
PSM 142014	14	20	14
PSM 142020	14	20	20
PSM 142030	14	20	30
PSM 152115	15	21	15
PSM 152125	15	21	25
PSM 152216	15	22	16
PSM 152220	15	22	20
PSM 152230	15	22	30
PSM 162012	16	20	12
PSM 162016	16	20	16
PSM 162025	16	20	25
PSM 162216	16	22	16
PSM 162220	16	22	20
PSM 162225	16	22	25
PSM 162230	16	22	30
PSM 182418	18	24	18
PSM 182430	18	24	30
PSM 182516	18	25	16
PSM 182520	18	25	20
PSM 182530	18	25	30

Designation	d mm	D mm	B mm
PSM 202515	20	25	15
PSM 202520	20	25	20
PSM 202525	20	25	25
PSM 202530	20	25	30
PSM 202615	20	26	15
PSM 202620	20	26	20
PSM 202625	20	26	25
PSM 202630	20	26	30
PSM 202820	20	28	20
PSM 202830	20	28	30
PSM 202840	20	28	40
PSM 222720	22	27	20
PSM 222725	22	27	25
PSM 253020	25	30	20
PSM 253025	25	30	25
PSM 253030	25	30	30
PSM 253220	25	32	20
PSM 253225	25	32	25
PSM 253230	25	32	30
PSM 253235	25	32	35
PSM 253525	25	35	25
PSM 253535	25	35	35
PSM 253550	25	35	50
PSM 303820	30	38	20
PSM 303825	30	38	25
PSM 303830	30	38	30
PSM 303840	30	38	40
PSM 304030	30	40	30
PSM 304045	30	40	45
PSM 304060	30	40	60
PSM 354535	35	45	35
PSM 354540	35	45	40
PSM 354550	35	45	50
PSM 405030	40	50	30
PSM 405040	40	50	40
PSM 405050	40	50	50
PSM 405060	40	50	60
PSM 455535	45	55	35
PSM 455545	45	55	45
PSM 455560	45	55	60
PSM 506035	50	60	35
PSM 506050	50	60	50

Other dimensions available on request

SKF Sintered Bronze – flanged cylindrical bushings

Construction of designation:

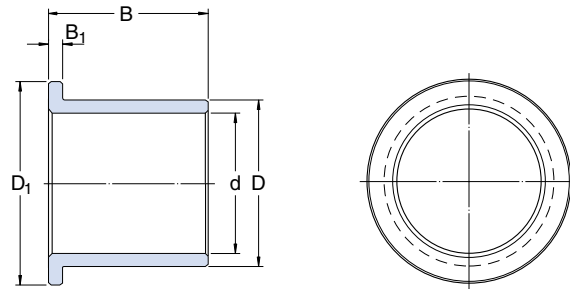

Designation	d mm	D mm	B mm	D ₁ mm	B ₁ mm
PSMF 081208	8	12	8	16	2
PSMF 081212	8	12	12	16	2
PSMF 101608	10	16	8	22	3
PSMF 101610	10	16	10	22	3
PSMF 101616	10	16	16	22	3
PSMF 121810	12	18	10	24	3
PSMF 121812	12	18	12	24	3
PSMF 121820	12	18	20	24	3
PSMF 142012	14	20	12	26	3
PSMF 142014	14	20	14	26	3
PSMF 142020	14	20	20	26	3
PSMF 152110	15	21	10	27	3
PSMF 152115	15	21	15	27	3
PSMF 152125	15	21	25	27	3
PSMF 152212	15	22	12	28	3
PSMF 152216	15	22	16	28	3
PSMF 162212	16	22	12	28	3
PSMF 162216	16	22	16	28	3
PSMF 162225	16	22	25	28	3
PSMF 182412	18	24	12	30	3
PSMF 182418	18	24	18	30	3
PSMF 182430	18	24	30	30	3

Designation	d mm	D mm	B mm	D ₁ mm	B ₁ mm
PSMF 202615	20	26	15	32	3
PSMF 202620	20	26	20	32	3
PSMF 202625	20	26	25	32	3
PSMF 202630	20	26	30	32	3
PSMF 202816	20	28	16	35	4
PSMF 202820	20	28	20	35	4
PSMF 253220	25	32	20	39	3,5
PSMF 253225	25	32	25	39	3,5
PSMF 253230	25	32	30	39	3,5
PSMF 253516	25	35	16	45	5
PSMF 253525	25	35	25	45	5
PSMF 304020	30	40	20	50	5
PSMF 304030	30	40	30	50	5
PSMF 354525	35	45	25	55	5
PSMF 354535	35	45	35	55	5
PSMF 405030	40	50	30	60	5
PSMF 405040	40	50	40	60	5
PSMF 506035	50	60	35	70	5
PSMF 506050	50	60	50	70	5

Other dimensions available on request

SKF Wrapped Bronze – plain cylindrical bushings

Construction of designation:

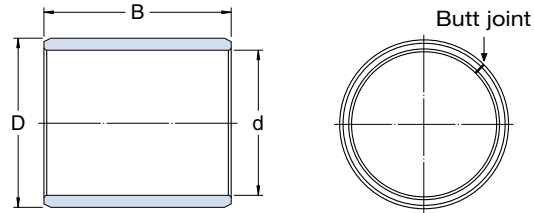
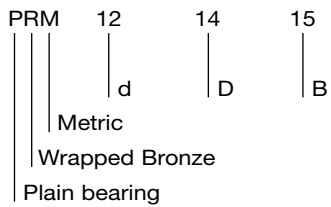

Designation	d mm	D mm	B mm
PRM 121415	12	14	15
PRM 151715	15	17	15
PRM 151725	15	17	25
PRM 161815	16	18	15
PRM 161820	16	18	20
PRM 161825	16	18	25
PRM 182115	18	21	15
PRM 182120	18	21	20
PRM 182125	18	21	25
PRM 202315	20	23	15
PRM 202320	20	23	20
PRM 202325	20	23	25
PRM 202330	20	23	30
PRM 252815	25	28	15
PRM 252820	25	28	20
PRM 252825	25	28	25
PRM 252830	25	28	30
PRM 303420	30	34	20
PRM 303430	30	34	30
PRM 303440	30	34	40
PRM 323620	32	36	20
PRM 323630	32	36	30
PRM 353920	35	39	20
PRM 353930	35	39	30
PRM 353940	35	39	40
PRM 353950	35	39	50
PRM 404420	40	44	20
PRM 404430	40	44	30
PRM 404440	40	44	40
PRM 404450	40	44	50

Designation	d mm	D mm	B mm
PRM 455030	45	50	30
PRM 455040	45	50	40
PRM 455050	45	50	50
PRM 455060	45	50	60
PRM 505530	50	55	30
PRM 505540	50	55	40
PRM 505550	50	55	50
PRM 505560	50	55	60
PRM 556040	55	60	40
PRM 556060	55	60	60
PRM 606530	60	65	30
PRM 606540	60	65	40
PRM 606550	60	65	50
PRM 606560	60	65	60
PRM 657040	65	70	40
PRM 657060	65	70	60
PRM 707540	70	75	40
PRM 707560	70	75	60
PRM 707580	70	75	80
PRM 758080	75	80	80
PRM 808540	80	85	40
PRM 808560	80	85	60
PRM 808580	80	85	80
PRM 859080	85	90	80
PRM 909550	90	95	50
PRM 909590	90	95	90
PRM 10010550	100	105	50
PRM 10010595	100	105	95

Other dimensions available on request

SKF Wrapped Bronze – flanged cylindrical bushings

Construction of designation:

PRMF	20	23	16
	d	D	B
	Flanged		
	Metric		
	Wrapped Bronze		
	Plain bearing		

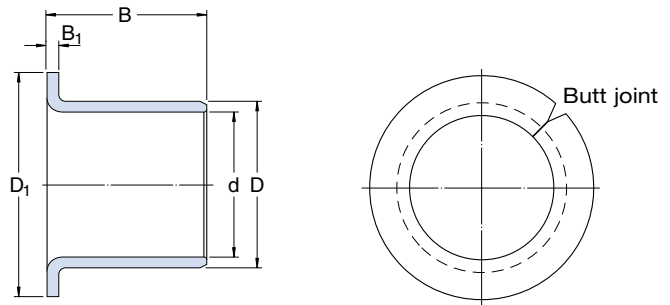

Designation	d mm	D mm	B mm	D ₁ mm	B ₁ mm
PRMF 202316	20	23	16	30	1,5
PRMF 202320	20	23	20	30	1,5
PRMF 252815	25	28	15	35	1,5
PRMF 252825	25	28	25	35	1,5
PRMF 303420	30	34	20	45	2
PRMF 303430	30	34	30	45	2
PRMF 353920	35	39	20	50	2
PRMF 353935	35	39	35	50	2
PRMF 404425	40	44	25	55	2
PRMF 404440	40	44	40	55	2
PRMF 455030	45	50	30	60	2,5
PRMF 455045	45	50	45	60	2,5
PRMF 505530	50	55	30	65	2,5
PRMF 505550	50	55	50	65	2,5

Designation	d mm	D mm	B mm	D ₁ mm	B ₁ mm
PRMF 556050	55	60	50	70	2,5
PRMF 606530	60	65	30	75	2,5
PRMF 606560	60	65	60	75	2,5
PRMF 657060	65	70	60	80	2,5
PRMF 707540	70	75	40	85	2,5
PRMF 707570	70	75	70	85	2,5
PRMF 758070	75	80	70	90	2,5
PRMF 808540	80	85	40	100	2,5
PRMF 808580	80	85	80	100	2,5
PRMF 909550	90	95	50	110	2,5
PRMF 10010550	100	105	50	120	2,5

SKF PTFE Composite – plain cylindrical bushings

Construction of designation:

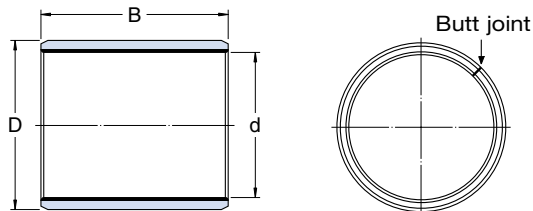
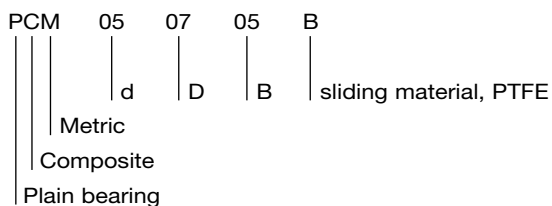

Designation	d mm	D mm	B mm	Designation	d mm	D mm	B mm
PCM 030403 B/VB055	3	4,5	3	PCM 182015 B	18	20	15
PCM 030405 B/VB055	3	4,5	5	PCM 182020 B	18	20	20
PCM 030406 B/VB055	3	4,5	6	PCM 182025 B	18	20	25
PCM 040504 B/VB055	4	5,5	4	PCM 202210 B	20	22	10
PCM 040506 B/VB055	4	5,5	6	PCM 202220 B	20	22	20
PCM 040510 B/VB055	4	5,5	10	PCM 202310 B	20	23	10
PCM 050705 B	5	7	5	PCM 202315 B	20	23	15
PCM 050708 B	5	7	8	PCM 202320 B	20	23	20
PCM 050710 B	5	7	10	PCM 202325 B	20	23	25
PCM 060806 B	6	8	6	PCM 202330 B	20	23	30
PCM 060808 B	6	8	8	PCM 222515 B	22	25	15
PCM 060810 B	6	8	10	PCM 222520 B	22	25	20
PCM 081006 B	8	10	6	PCM 222525 B	22	25	25
PCM 081008 B	8	10	8	PCM 222530 B	22	25	30
PCM 081010 B	8	10	10	PCM 242715 B	24	27	15
PCM 081012 B	8	10	12	PCM 242720 B	24	27	20
PCM 101208 B	10	12	8	PCM 242730 B	24	27	30
PCM 101210 B	10	12	10	PCM 252815 B	25	28	15
PCM 101212 B	10	12	12	PCM 252820 B	25	28	20
PCM 101215 B	10	12	15	PCM 252825 B	25	28	25
PCM 101220 B	10	12	20	PCM 252830 B	25	28	30
PCM 121408 B	12	14	8	PCM 283220 B	28	32	20
PCM 121410 B	12	14	10	PCM 283225 B	28	32	25
PCM 121412 B	12	14	12	PCM 283230 B	28	32	30
PCM 121415 B	12	14	15	PCM 303415 B	30	34	15
PCM 121420 B	12	14	20	PCM 303420 B	30	34	20
PCM 121425 B	12	14	25	PCM 303425 B	30	34	25
PCM 141610 B	14	16	10	PCM 303430 B	30	34	30
PCM 141612 B	14	16	12	PCM 303440 B	30	34	40
PCM 141615 B	14	16	15	PCM 323620 B	32	36	20
PCM 141620 B	14	16	20	PCM 323630 B	32	36	30
PCM 141625 B	14	16	25	PCM 323640 B	32	36	40
PCM 151710 B	15	17	10	PCM 353920 B	35	39	20
PCM 151712 B	15	17	12	PCM 353930 B	35	39	30
PCM 151715 B	15	17	15	PCM 353940 B	35	39	40
PCM 151720 B	15	17	20	PCM 353950 B	35	39	50
PCM 151725 B	15	17	25	PCM 374020 B	37	40	20
PCM 161810 B	16	18	10	PCM 404420 B	40	44	20
PCM 161812 B	16	18	12	PCM 404430 B	40	44	30
PCM 161815 B	16	18	15	PCM 404440 B	40	44	40
PCM 161820 B	16	18	20	PCM 404450 B	40	44	50
PCM 161825 B	16	18	25				

Other dimensions available on request

Designation	d mm	D mm	B mm
PCM 455020 B	45	50	20
PCM 455030 B	45	50	30
PCM 455040 B	45	50	40
PCM 455050 B	45	50	50
PCM 505520 B	50	55	20
PCM 505530 B	50	55	30
PCM 505540 B	50	55	40
PCM 505560 B	50	55	60
PCM 556030 B	55	60	30
PCM 556040 B	55	60	40
PCM 556060 B	55	60	60
PCM 606520 B	60	65	20
PCM 606530 B	60	65	30
PCM 606540 B	60	65	40
PCM 606560 B	60	65	60
PCM 606570 B	60	65	70
PCM 657030 B	65	70	30
PCM 657050 B	65	70	50
PCM 657070 B	65	70	70
PCM 707540 B	70	75	40
PCM 707550 B	70	75	50
PCM 707570 B	70	75	70
PCM 758060 B	75	80	60
PCM 758080 B	75	80	80
PCM 808560 B	80	85	60
PCM 8085100 B	80	85	100
PCM 859030 B	85	90	30
PCM 859060 B	85	90	60
PCM 909560 B	90	95	60
PCM 9095100 B	90	95	100
PCM 9510060 B	95	100	60
PCM 10010560 B	100	105	60
PCM 100105115 B	100	105	115
PCM 11011560 B	110	115	60
PCM 110115115 B	110	115	115
PCM 12012560 B	120	125	60
PCM 120125100 B	120	125	100
PCM 130135100 B	130	135	100

Designation	d mm	D mm	B mm
PCM 14014560 B	140	145	60
PCM 140145100 B	140	145	100
PCM 15015560 B	150	155	60
PCM 15015580 B	150	155	80
PCM 150155100 B	150	155	100
PCM 160165100 B	160	165	100
PCM 180185100 B	180	185	100
PCM 200205100 B	200	205	100

Other dimensions available on request

SKF PTFE Composite – flanged cylindrical bushings

Construction of designation:

PCMF 06 08 04 B
 | | | | |
 | | | | | sliding material, PTFE
 | | | | |
 | | | | | Flanged
 | | | | | Metric
 | | | | | Composite
 | | | | | Plain bearing

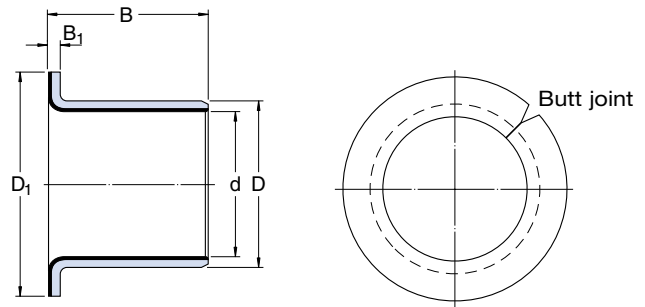

Designation	d mm	D mm	B mm	D ₁ mm	B ₁ mm
PCMF 060804 B	6	8	4	12	1
PCMF 060808 B	6	8	8	12	1
PCMF 081005.5 B	8	10	5,5	15	1
PCMF 081007.5 B	8	10	7,5	15	1
PCMF 081009.5 B	8	10	9,5	15	1
PCMF 101207 B	10	12	7	18	1
PCMF 101209 B	10	12	9	18	1
PCMF 101212 B	10	12	12	18	1
PCMF 101217 B	10	12	17	18	1
PCMF 121407 B	12	14	7	20	1
PCMF 121409 B	12	14	9	20	1
PCMF 121412 B	12	14	12	20	1
PCMF 121415 B	12	14	15	20	1
PCMF 121417 B	12	14	17	20	1
PCMF 141612 B	14	16	12	22	1
PCMF 141617 B	14	16	17	22	1
PCMF 151709 B	15	17	9	23	1
PCMF 151712 B	15	17	12	23	1
PCMF 151717 B	15	17	17	23	1

Designation	d mm	D mm	B mm	D ₁ mm	B ₁ mm
PCMF 161812 B	16	18	12	24	1
PCMF 161817 B	16	18	17	24	1
PCMF 182012 B	18	20	12	26	1
PCMF 182017 B	18	20	17	26	1
PCMF 182022 B	18	20	22	26	1
PCMF 202311.5 B	20	23	11,5	30	1,5
PCMF 202315 B	20	23	15	30	1,5
PCMF 202316.5 B	20	23	16,5	30	1,5
PCMF 202321.5 B	20	23	21,5	30	1,5
PCMF 252811.5 B	25	28	11,5	35	1,5
PCMF 252816.5 B	25	28	16,5	35	1,5
PCMF 252821.5 B	25	28	21,5	35	1,5
PCMF 303416 B	30	34	16	42	2
PCMF 303426 B	30	34	26	42	2
PCMF 353916 B	35	39	16	47	2
PCMF 353926 B	35	39	26	47	2

Other dimensions available on request

SKF PTFE Composite – thrust washers

Construction of designation:

PCMW 10 20 01,5 B
 | | | | |
 | | | | | sliding material, PTFE
 | | | | | Thrust washer
 | | | | | Metric
 | | | | | Composite
 | | | | | Plain bearing

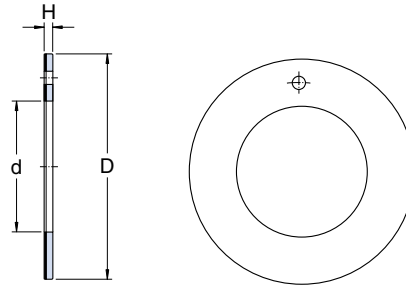

Designation	d mm	D mm	H mm
PCMW 102001.5 B	10	20	1,5
PCMW 122401.5 B	12	24	1,5
PCMW 142601.5 B	14	26	1,5
PCMW 183201.5 B	18	32	1,5
PCMW 203601.5 B	20	36	1,5
PCMW 223801.5 B	22	38	1,5

Designation	d mm	D mm	H mm
PCMW 264401.5 B	26	44	1,5
PCMW 284801.5 B	28	48	1,5
PCMW 325401.5 B	32	54	1,5
PCMW 386201.5 B	38	62	1,5
PCMW 426601.5 B	42	66	1,5
PCMW 527802 B	52	78	2

SKF PTFE Composite – strips

Construction of designation:

PCMS 100 500 0,75 B
 | | | | |
 | | | | | sliding material, PTFE
 | | | | | Strip
 | | | | | Metric
 | | | | | Composite
 | | | | | Plain bearing

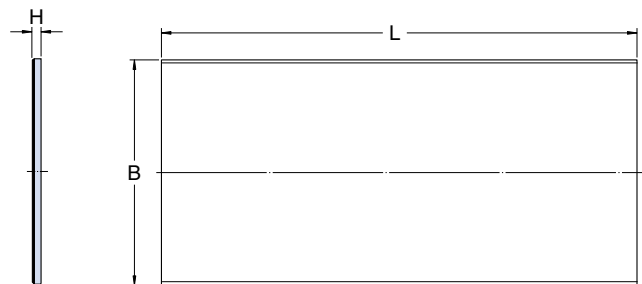

Designation	B mm	L mm	H mm
PCMS 1005000.75 B	100	500	0,75
PCMS 1005001.0 B	100	500	1
PCMS 1005001.50 B	100	500	1,5

Designation	B mm	L mm	H mm
PCMS 1005002.0 B	100	500	2
PCMS 1005002.50 B	100	500	2,5
PCMS 1005003.06 B	100	500	3,06

Other dimensions available on request

SKF POM Composite – plain cylindrical bushings

Construction of designation:

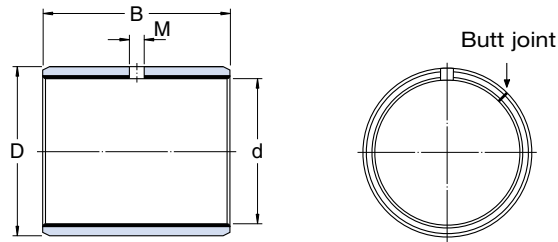
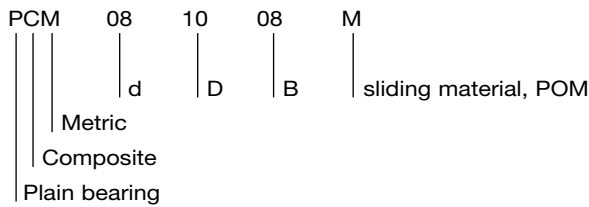

Designation	d mm	D mm	B mm	M mm	Designation	d mm	D mm	B mm	M mm
PCM 081008 M	8	10	8	–	PCM 353920 M	35	39	20	4
PCM 081010 M	8	10	10	–	PCM 353930 M	35	39	30	4
PCM 081012 M	8	10	12	–	PCM 353950 M	35	39	50	4
PCM 101210 M	10	12	10	–	PCM 404420 M	40	44	20	4
PCM 101212 M	10	12	12	3	PCM 404430 M	40	44	30	4
PCM 101215 M	10	12	15	3	PCM 404440 M	40	44	40	4
PCM 101220 M	10	12	20	3	PCM 404450 M	40	44	50	4
PCM 121410 M	12	14	10	3	PCM 455030 M	45	50	30	5
PCM 121415 M	12	14	15	3	PCM 455040 M	45	50	40	5
PCM 121420 M	12	14	20	3	PCM 455050 M	45	50	50	5
PCM 141620 M	14	16	20	3	PCM 505530 M	50	55	30	5
PCM 141625 M	14	16	25	3	PCM 505540 M	50	55	40	5
PCM 151715 M	15	17	15	3	PCM 505560 M	50	55	60	5
PCM 161815 M	16	18	15	3	PCM 556040 M	55	60	40	6
PCM 161820 M	16	18	20	3	PCM 606530 M	60	65	30	6
PCM 161825 M	16	18	25	3	PCM 606540 M	60	65	40	6
PCM 182015 M	18	20	15	3	PCM 606560 M	60	65	60	6
PCM 182020 M	18	20	20	3	PCM 606570 M	60	65	70	6
PCM 182025 M	18	20	25	3	PCM 657050 M	65	70	50	6
PCM 202310 M	20	23	10	3	PCM 657070 M	65	70	70	6
PCM 202315 M	20	23	15	3	PCM 707540 M	70	75	40	6
PCM 202320 M	20	23	20	3	PCM 707550 M	70	75	50	6
PCM 202325 M	20	23	25	3	PCM 707570 M	70	75	70	6
PCM 202330 M	20	23	30	3	PCM 758040 M	75	80	40	6
PCM 222515 M	22	25	15	3	PCM 758060 M	75	80	60	6
PCM 222520 M	22	25	20	3	PCM 808540 M	80	85	40	6
PCM 222525 M	22	25	25	3	PCM 808560 M	80	85	60	6
PCM 252815 M	25	28	15	4	PCM 808580 M	80	85	80	6
PCM 252820 M	25	28	20	4	PCM 8085100 M	80	85	100	6
PCM 252825 M	25	28	25	4	PCM 859060 M	85	90	60	6
PCM 252830 M	25	28	30	4	PCM 909560 M	90	95	60	6
PCM 283220 M	28	32	20	4	PCM 9095100 M	90	95	100	6
PCM 283225 M	28	32	25	4	PCM 9510060 M	95	100	60	6
PCM 283230 M	28	32	30	4	PCM 10010560 M	100	105	60	6
PCM 303420 M	30	34	20	4	PCM 10010580 M	100	105	80	6
PCM 303430 M	30	34	30	4	PCM 100105115 M	100	105	115	6
PCM 303440 M	30	34	40	4					
PCM 323630 M	32	36	30	4					

Other dimensions available on request

Designation	d mm	D mm	B mm	M mm
PCM 11011560 M	110	115	60	8
PCM 110115115 M	110	115	115	8
PCM 12012560 M	120	125	60	8
PCM 120125100 M	120	125	100	8
PCM 130135100 M	130	135	100	8
PCM 14014560 M	140	145	60	8
PCM 15015560 M	150	155	60	8

Other dimensions available on request

SKF Stainless Backed Composite – plain cylindrical bushings

Construction of designation:

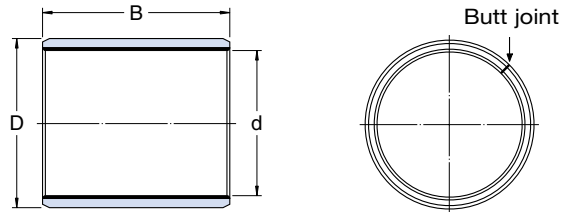
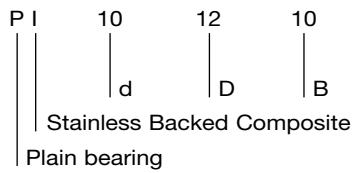

Designation	d mm	D mm	B mm
PI 101210	10	12	10
PI 101215	10	12	15
PI 121410	12	14	10
PI 141620	14	16	20
PI 151720	15	17	20
PI 161809	16	18	9
PI 161820	16	18	20
PI 182020	18	20	20
PI 202315	20	23	15
PI 202320	20	23	20
PI 222520	22	25	20
PI 252820	25	28	20
PI 252825	25	28	25
PI 303415	30	34	15
PI 303425	30	34	25
PI 353925	35	39	25
PI 353940	35	39	40
PI 404525	40	45	25
PI 404540	40	45	40
PI 455025	45	50	25
PI 455040	45	50	40
PI 505540	50	55	40
PI 556040	55	60	40
PI 606540	60	65	40
PI 606560	60	65	60
PI 707560	70	75	60
PI 808560	80	85	60
PI 909560	90	95	60
PI 10010560	100	105	60
PI 10010590	100	105	90
PI 11011560	110	115	60
PI 12012560	120	125	60

Designation	d mm	D mm	B mm
PI 13013560	130	135	60
PI 14014590	140	145	90
PI 15015560	150	155	60

Other dimensions available on request

SKF PTFE Polyamide – flanged cylindrical bushings

Construction of designation:

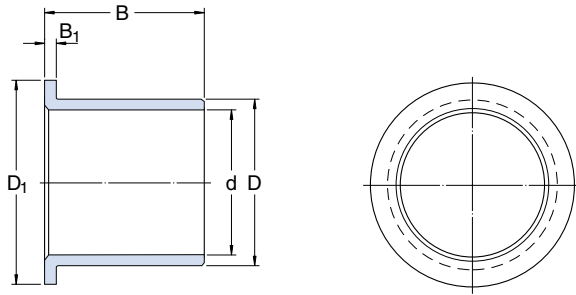
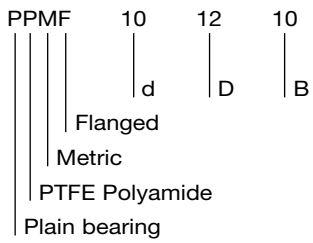

Designation	d mm	D mm	B mm	D ₁ mm	B ₁ mm
PPMF 101207	10	12	7	18	1
PPMF 101212	10	12	12	18	1
PPMF 121409	12	14	9	20	1
PPMF 121412	12	14	12	20	1
PPMF 141612	14	16	12	22	1
PPMF 141617	14	16	17	22	1

Designation	d mm	D mm	B mm	D ₁ mm	B ₁ mm
PPMF 151712	15	17	12	23	1
PPMF 151717	15	17	17	23	1
PPMF 161817	16	18	17	24	1
PPMF 202311.5	20	23	11,5	30	1,5
PPMF 202321.5	20	23	21,5	30	1,5
PPMF 252811.5	25	28	11,5	35	1,5
PPMF 252821.5	25	28	21,5	35	1,5

Other dimensions available on request

SKF Filament Wound – plain cylindrical bushings

Construction of designation:

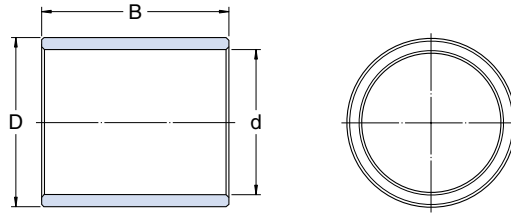
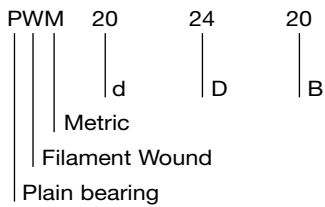

Designation	d mm	D mm	B mm
PWM 202420	20	24	20
PWM 202430	20	24	30
PWM 253030	25	30	30
PWM 253040	25	30	40
PWM 303620	30	36	20
PWM 303630	30	36	30
PWM 303640	30	36	40
PWM 354130	35	41	30
PWM 354140	35	41	40
PWM 354150	35	41	50
PWM 404830	40	48	30
PWM 404840	40	48	40
PWM 404860	40	48	60
PWM 455330	45	53	30
PWM 455340	45	53	40
PWM 455360	45	53	60
PWM 505840	50	58	40
PWM 505850	50	58	50
PWM 505860	50	58	60
PWM 556340	55	63	40
PWM 556350	55	63	50
PWM 556370	55	63	70
PWM 607040	60	70	40
PWM 607060	60	70	60
PWM 607080	60	70	80
PWM 657550	65	75	50
PWM 657560	65	75	60
PWM 657580	65	75	80
PWM 708050	70	80	50
PWM 708070	70	80	70
PWM 708090	70	80	90
PWM 758550	75	85	50
PWM 758570	75	85	70
PWM 758590	75	85	90
PWM 809060	80	90	60
PWM 809080	80	90	80
PWM 8090100	80	90	100
PWM 859560	85	95	60
PWM 859580	85	95	80
PWM 8595100	85	95	100

Designation	d mm	D mm	B mm
PWM 9010560	90	105	60
PWM 9010580	90	105	80
PWM 90105120	90	105	120
PWM 9511060	95	110	60
PWM 95110100	95	110	100
PWM 95110120	95	110	120
PWM 10011580	100	115	80
PWM 100115100	100	115	100
PWM 100115120	100	115	120
PWM 11012580	110	125	80
PWM 110125100	110	125	100
PWM 110125120	110	125	120
PWM 120135100	120	135	100
PWM 120135120	120	135	120
PWM 120135150	120	135	150

Other dimensions available on request



© Copyright SKF 1999

The contents of this publication are the copyright of the publisher and may not be reproduced (even extracts) unless permission is granted. Every care has been taken to ensure the accuracy of the information contained in this publication but no liability can be accepted for any loss or damage whether direct, indirect or consequential arising out of the use of the information contained herein.

Publication **4741 E**

Printed in Sweden on environmentally friendly, chlorine-free paper (Multiart Silk) by Halls Offset AB.

The SKF logo is rendered in a bold, stylized, outlined font. The letters are interconnected, with the 'S' and 'K' sharing a vertical stroke, and the 'F' having a distinctive shape with a horizontal top bar.